

KREBS®

PUMPS, CYCLONES AND VALVES

SmartCyclone™

Optimisation and condition monitoring solutions

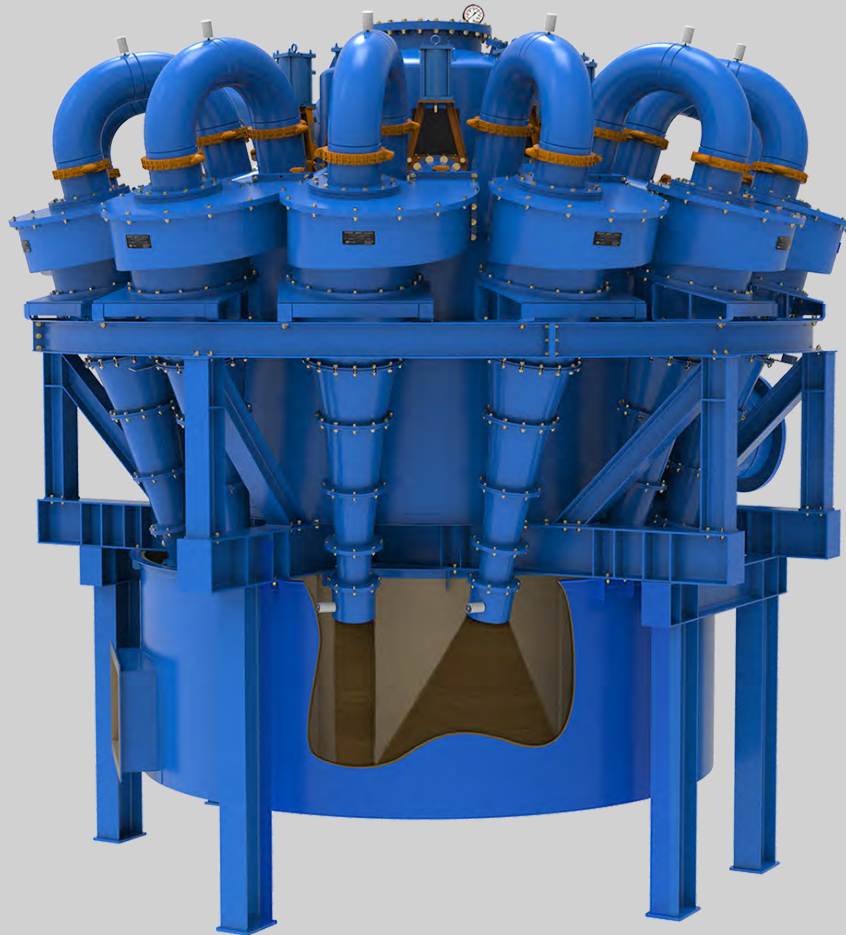

SmartCyclone™ solutions for process optimisation

Our control solution targets the closed-circuit grinding process with a dedicated automation philosophy—helping your plant to achieve maximum process efficiency.

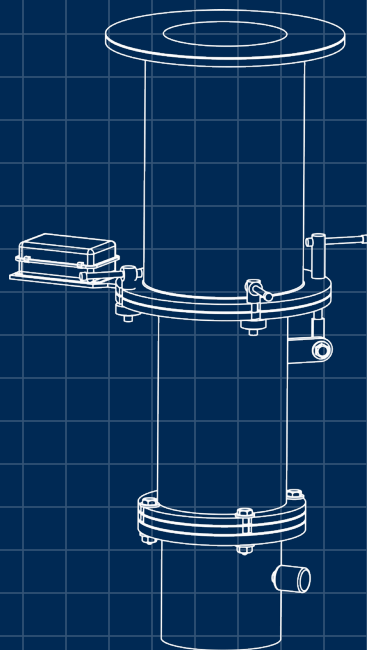

Key benefits

■ Quick identification and correction of process upsets

– Less process downtime

■ Reduced variation in flotation particle size distribution

– Improved mineral recovery

■ Predictable cyclone maintenance schedule

– Improved process stability
–and wear monitoring

■ Increased production capacity

– Ability to run the plant closer to the cyclone design limits

New wireless technology for condition monitoring

Our SmartCyclone™ is an automated system that uses sensors to monitor the cyclone parameters. It identifies cyclone-related process upsets in grinding processes.

The complete SmartCyclone™ system is comprised of the following patented components:

- KREBS® Smartcyclone™
- Wear detection sensor technology
- Roping detection sensor technology
- Wireless control system
- ECS/ProcessExpert® process control software

The SmartCyclone™ system uses electronic sensing to communicate between KREBS hydrocyclone separator products and the encompassing process, creating what is called an "island of optimisation" for mineral processing and specialty markets.

Within the system, the SmartCyclone™ roping sensors report the functional state of the hydrocyclone by monitoring the slurry flow conditions for each cyclone.

The wear sensors report the wear status of the cyclone components, giving your operation greater control to plan ahead for purchasing parts and scheduling maintenance. The roping sensor reports when a cyclone, or the SmartCyclone™ system itself, is malfunctioning—such as when an individual cyclone experiences a condition called “roping,” or a breakdown in the classification.



SmartCyclone™ wireless sensors

Industry breakthrough

A single central wireless controller handles up to 16 sensors per unit. It provides real-time wireless detection and communication of roping and wear data, which is forwarded via Ethernet cable from the roping detection sensor technology to the control room workstation.

The new wireless controller unit is a handheld device that can be removed from its docking/charging station to sync the individual sensors. The operator removes it from the dock, walks to a desired sensor, activates it with a magnet located within the device and sets the necessary operating parameters. After completing the process, the user places the controller unit back onto its docking station, where it can communicate live operating data to the control room.

More compact system

- Eliminates node boxes for each cyclone
- Utilises one central controller for up to 16 cyclones
- NEMA4X enclosure protects the controller within the dock

No cables or wires

- Controller's wireless antenna communicates with sensors
- Eliminates cable trays for a more streamlined installation
- Elimination of cables allows easy cyclone removal for maintenance



SmartCyclone™ hand-held wireless controller and docking station

SmartCyclone™ Expert

a modern optimisation package

As part of the SmartCyclone solution, the ECS/ProcessExpert software is a modern, advanced process control system that is able to first stabilise and then optimise key minerals processes. It balances equipment loads, manages and corrects process disruptions, and optimises wear on the plant's equipment. By dramatically reducing or eliminating manual involvement from your mill operators, ECS/ProcessExpert can consistently ensure optimum plant performance for maximum efficiency and higher profitability. In addition, the ECS/ProcessExpert solution enables you to develop a uniform operation strategy for the best way to run your plant. An established strategy greatly reduces the burden of training new operators.

Improved mineral recovery

By decreasing or eliminating coarse particle bypass to the cyclone overflow, the SmartCyclone™ system reduces variations in flotation particle size distribution, helping to improve overall mineral recovery and fully optimise your process.

Efficient control of the cyclone parameters results in a reduction in the variation of the particle size. Reducing standard deviation on particle size (P80) variation is an important performance indicator for the grinding circuit.

SmartCyclone™ Basic and Expert packages

	Basic	Expert
Roping	●	●
Wear	●	●
Roping and wear alarm	●	●
Condition monitoring based operation	X	●
Sump level control	X	●
Pump optimisation	X	●
Cyclone overflow particle size estimation	X	●
Cyclone inlet pressure optimisation	X	●
Cyclone inlet density/solids optimisation	X	●
Cyclone overflow optimisation	X	●
Circuit production maximisation	X	●
Cyclone balancing based on wear and operating time	X	●

By adding particle size distribution, slurry density and other process data into the SmartCyclone™ advanced software system, it can automatically alter process conditions to optimise circuit performance. The system can decrease or increase cyclone feed concentration, change the pump speed or open and close operating cyclones as needed.

Increased production capacity

A cyclone or battery of cyclones that are overloaded and experience roping result in a greater bypass of coarse solids reporting to the overflow. This directly hurts recovery and allows slurry to accumulate in the lines and flotation cells. By monitoring for roping, the SmartCyclone allows the operator to run the plant closer to the limits of the cyclone cluster design without worrying about overloading.

Safe monitoring of wear parts

Our SmartCyclone automated monitoring system allows employees to perform wear detection and troubleshooting from a control room without handling the equipment for visual inspections.

Reduced roping events

Our SmartCyclone™ stabilizes the entire secondary grinding circuit to reduce the number of roping events.

The FLSmidth ECS/Expert control system incorporates logic associated with various operating parameters to optimize the performance of the grinding circuit. A partial decision tree related to roping sensor values is represented below.

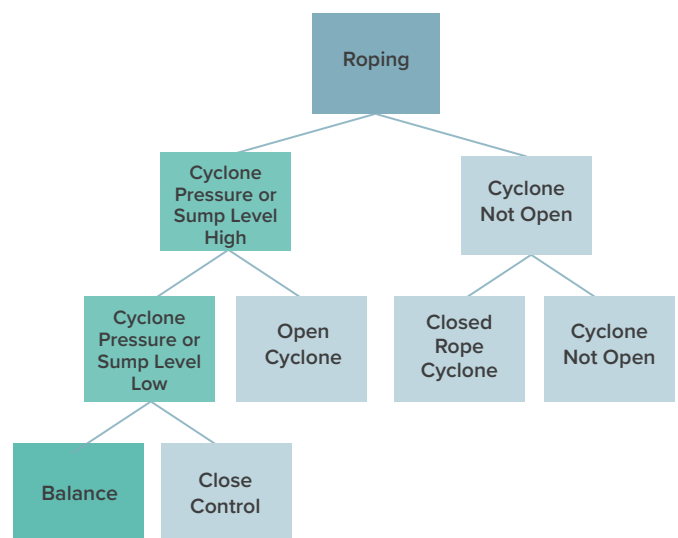

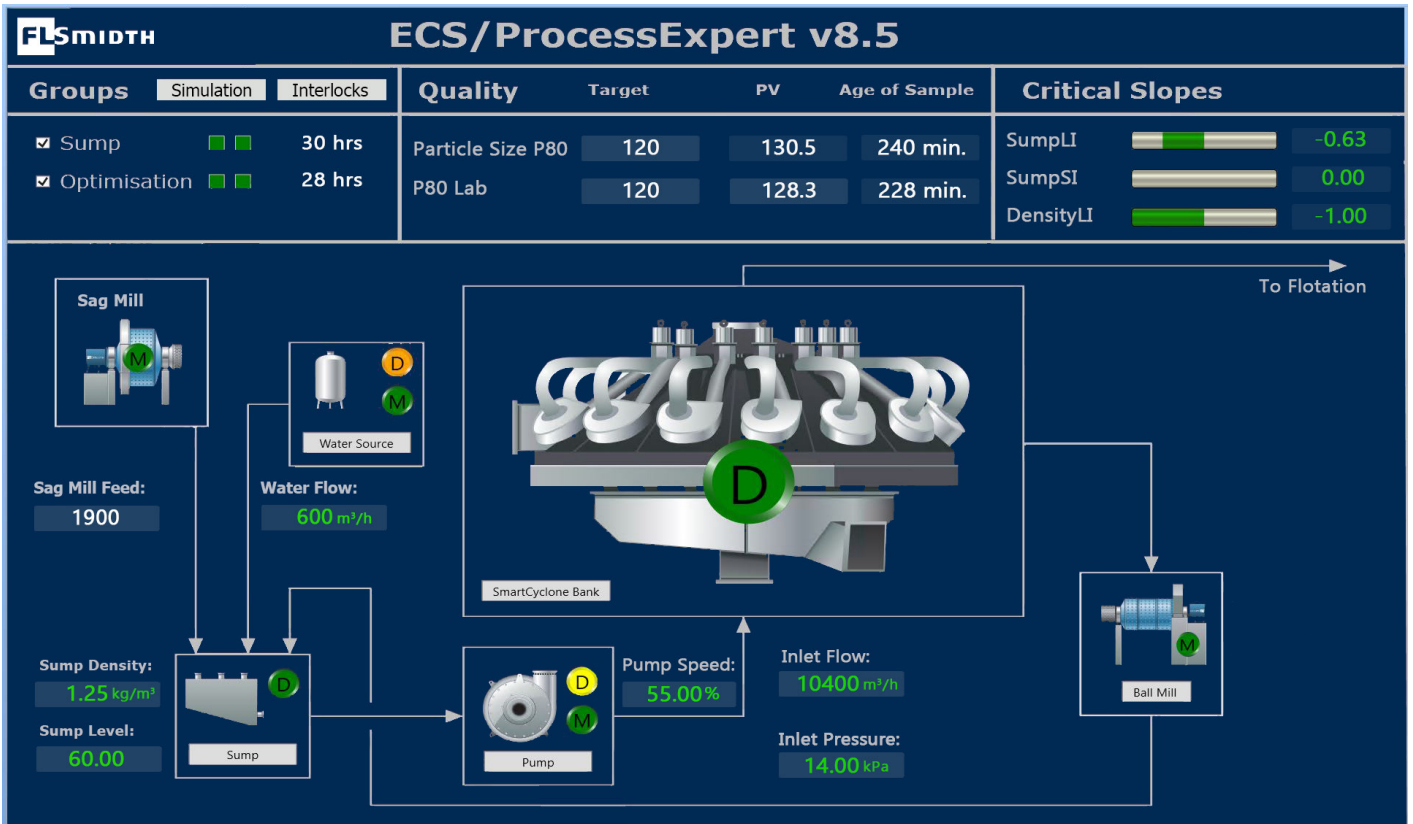

FLSmidth Process Control System showing grinding circuit “island of optimization” and some of the input parameters that are used to develop a comprehensive control strategy to maximize throughput and profitability in the comminution circuit.

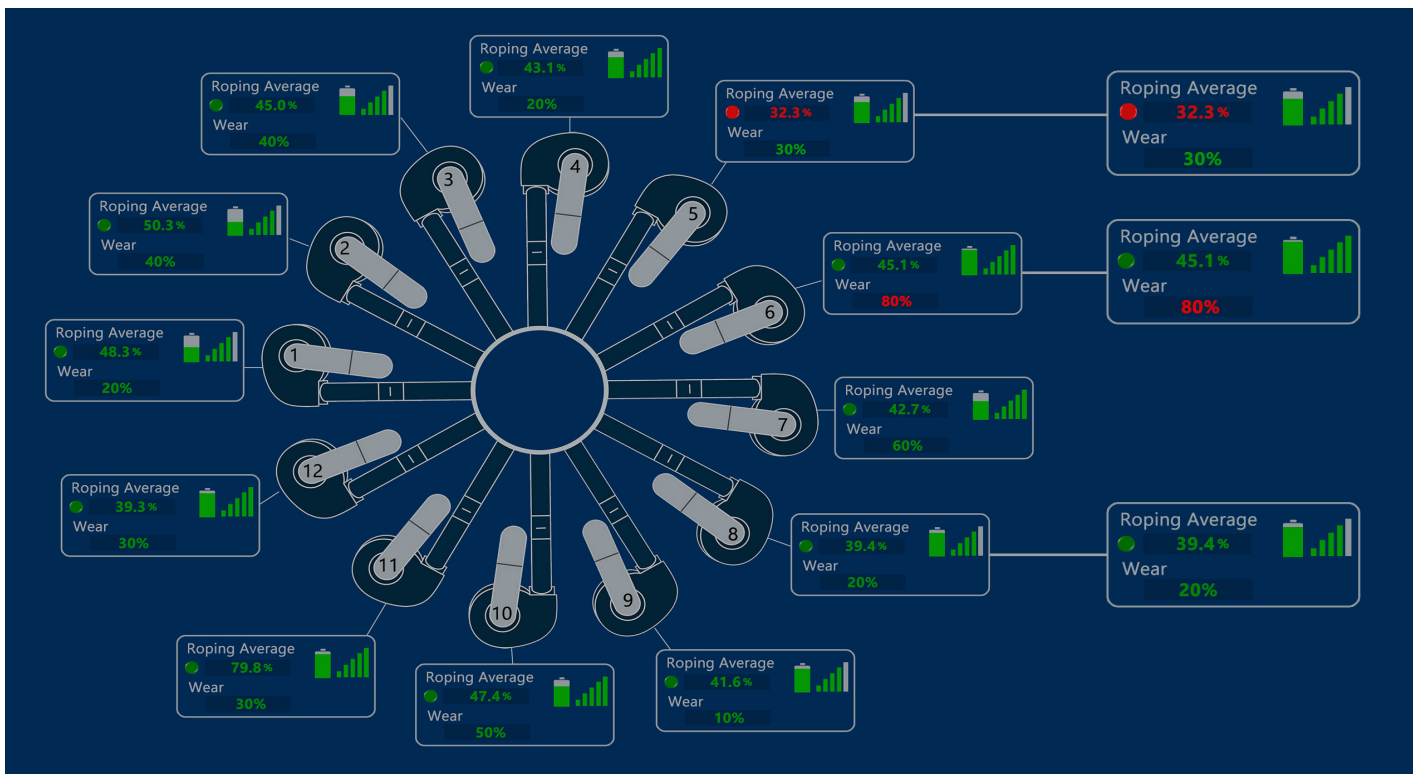

FLSmidth SmartCyclone display screen showing wireless roping sensor and wireless wear sensor output values. Operators can set warning and alarm values for these parameters.

New opportunities for productivity

Using the SmartCyclone, plants can achieve maximum process efficiencies through quick upset condition identification and correction. The efficiencies permit the process to be operated closer to the limits of the cyclone cluster design, reduce process downtime and reduce flotation feed variation. All of these benefits lead to:

- Improved mineral recovery
- Stabilized cyclone operation
- Continuous wear monitoring and management
- Predictable cyclone circuit maintenance
- Increased production capacity

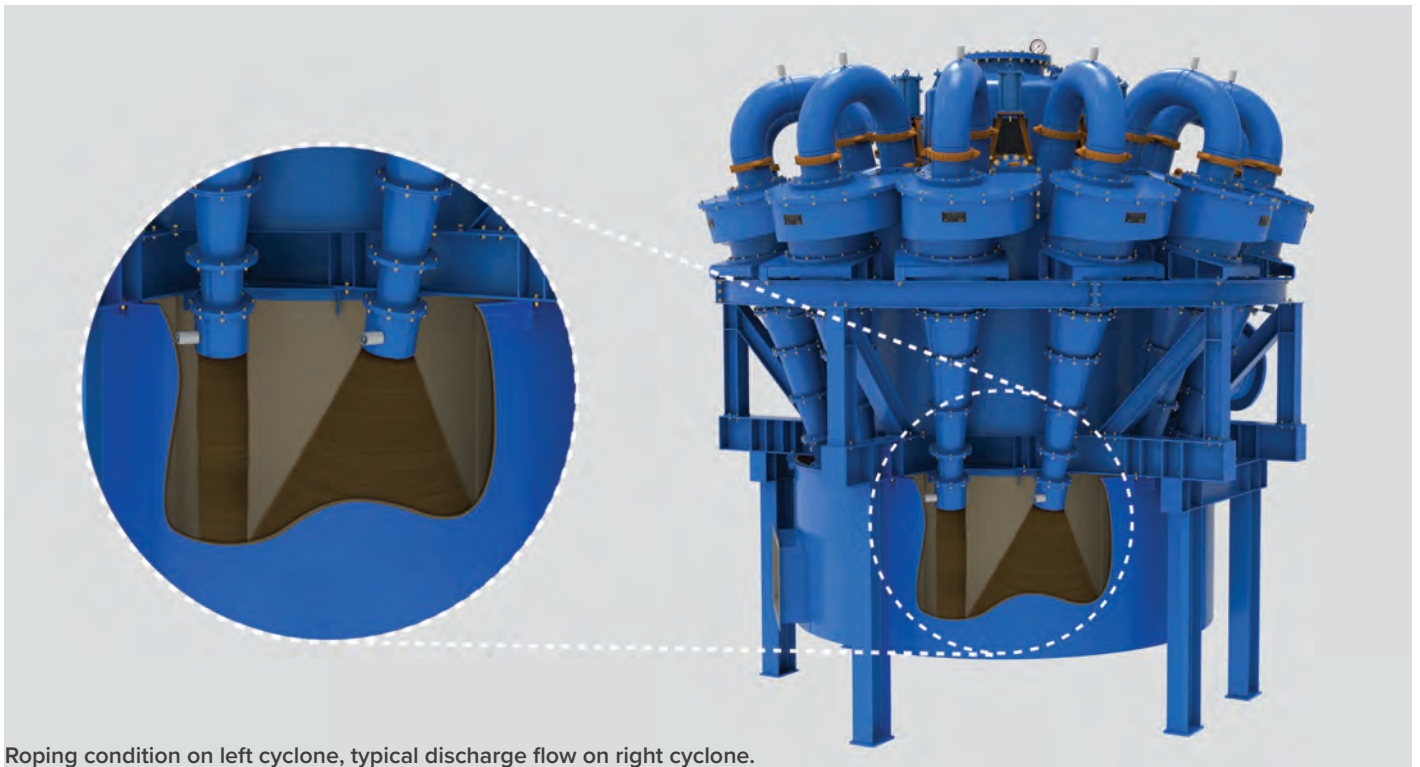

Roping condition on left cyclone, typical discharge flow on right cyclone.

We deliver reliability and slurry to your process

Our knife gate slurry valves are designed for the most demanding high-pressure applications.

✉ krebs@flsmidth.com

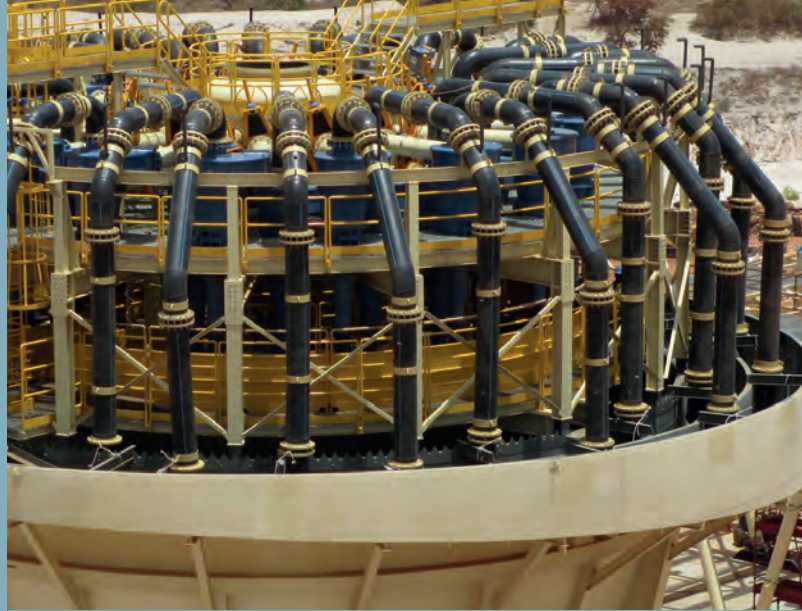

With KREBS® separation systems, it is easy to see what you have been missing

Achieve finer, sharper particle separations at high capacities.

🌐 www.flsmidth.com



Learn more
about our
KREBS® Pumps
www.flsmidth.com



Mission Zero



TOWARDS ZERO EMISSIONS IN MINING



**Zero water
waste**



**Zero
emissions**



**Zero energy
waste**



[flsmidth.com/linkedin](https://www.flsmidth.com/linkedin)



[flsmidth.com/twitter](https://www.flsmidth.com/twitter)



[flsmidth.com/facebook](https://www.flsmidth.com/facebook)



[flsmidth.com/instagram](https://www.flsmidth.com/instagram)



[flsmidth.com/youtube](https://www.flsmidth.com/youtube)

FLSmidth A/S

Vigerslev Allé 77
2500 Valby
Denmark

Tel. +45 36 18 10 00
Fax +45 36 30 18 20
info@flsmidth.com

Copyright © 2022 FLSmidth. ALL RIGHTS RESERVED. FLSmidth is a (registered) trademark of FLSmidth. This brochure makes no offers, representations or warranties (express or implied), and information and data contained in this brochure are for general reference only and may change at any time.